



Product Presentation
Pizza Ovens

**SVEBA
DAHLIN**

The baker's best friend





Market Leading Pizza Ovens from Sveba-Dahlen

Pizza is baked in different types of ovens, with different toppings and by different pizza chef's – each one with their own way of preparing and baking pizza.

For this reason, Sveba-Dahlen's pizza ovens are developed in close collaboration with experienced pizza chef's – from all over the world! All our models are robust and reliable, designed to satisfy the chef's preferences and requirements for functionality, comfort, and economy.

Find out more on our website www.sveba-dahlen.com



Pizza Oven Range

Classic Pizza Oven

Classic
Pizza Oven



Tunnel Pizza Oven

Tunnel
Pizza Oven



Trendy Pizza Oven

Trendy
Pizza Oven



Classic Pizza Oven

Classic Pizza Oven

With all the features you could wish for.

Sveba-Dahlen have delivered pizza ovens all over the world since 1970. Classic Pizza Oven is a robust and reliable oven designed to meet every user's requirements for functionality, convenience and economy.

Classic pizza oven is a reliable and durable oven in many sizes, built to withstand very high loads. The very well insulated oven chamber keeps the heat inside the chamber, where it should be, and it has double halogen lighting. The instrument panel is angled towards the oven door so it's easy to work with when working. The oven reaches the set temperature fast and each oven section as well as the top; bottom and front heat are separately controlled.

The Classic pizza ovens are modular, meaning that you can build your oven according to your production. The ovens are available in four different widths from 635 mm up to 1580 mm wide and can be built up to three decks high.

Options – Accessory Pizza Bench

Stainless steel outside with an easy to clean working surface will help you get more efficient in handling ingredients and making pizza. The toppings are stored in containers which are recessed and kept cool in the bench – always fresh and accessible ingredients.



Classic Pizza Oven model DC-22P.

MODEL	DOORS	W (WIDTH)
MP-2R	2	1 650 mm
MP-3R	3	2 100 mm
MP-4R	4	2 600 mm

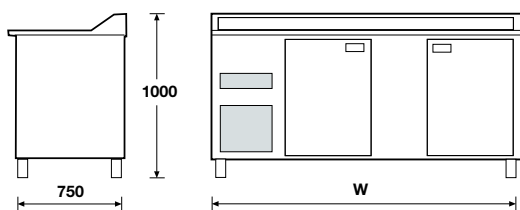

Features and benefits – Classic Pizza

- Flexible modul system
- Four standard sizes
- Stone soles gives the right pizza flavour
- Stepless and individual controls for front, top and bottom heat for each deck
- Ceramic glass in door and halogen lighting in the oven room
- Unloading shelf
- Canopy as standard
- Easy-to-use panel with turbo start, week timer and AC-guard

1 Robust and flexible design

Classic Pizza Oven is of modular design and available in four different widths. An oven can easily be upgraded in capacity up to maximum three decks.

Around the oven chamber Classic Pizza Oven has a 120 mm layer of rock wool insulation for superior heat economy and a safer working environment. The oven door is designed with ergonomic handles and a large window of ceramic glass. The double built-in halogen lighting distributes a warm and even light, has a longer life span and can withstand high temperatures.

A convenient unloading shelf, stone soles, stainless steel shelf stand and aluminium legs are standard execution on Classic Pizza Oven.

2 Efficient heat balance

Classic Pizza Oven has an efficient heat balance temperature control with individual controls for front, top and bottom zones. The result is a uniform temperature throughout the deck, even if the door is frequently opened.

Classic Pizza Oven quickly reaches the baking temperature, maximum 400° C. Each deck is regulated separately.

3 User-friendly instrument panel

The instrument panel with clearly visible symbols and controls is easy-to-use and angled towards the operator.

All controls are located on the right-hand side, which simplifies installation and servicing.



Technical

Model	DC-1P	DC-2P	DC-2EP	DC-3P
El. load (kW)	5,4	7,9	10,4	12,9

NOTE - El. load per section

Measurements

The sketch shows the depth and widths of the four different Classic Pizza Oven chambers.

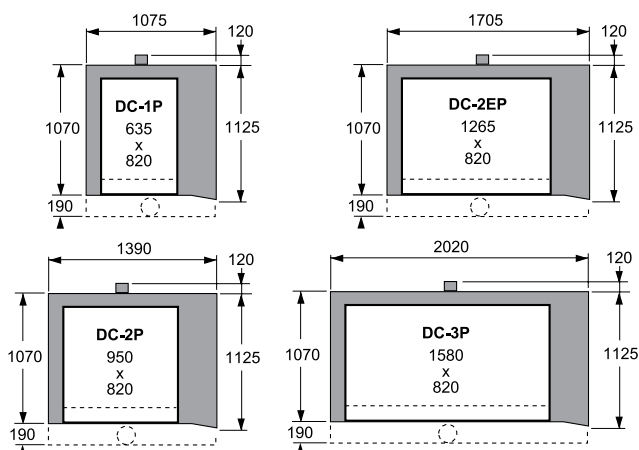

The sketch shows the heights of Classic Pizza Oven. Leg height (L) is adjusted according to the number of decks or customer requirements, from 100-1000 mm.

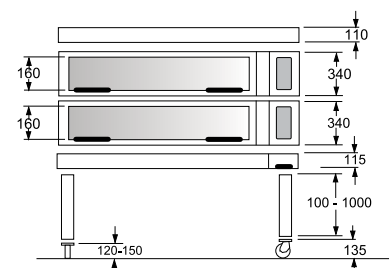

Subjects to changes without notice.

Tunnel Pizza Oven

Tunnel Pizza Oven

Large capacity in a small space.

Sveba-Dahlen has developed, marketed and manufactured pizza ovens for over 40 years, and the TP tunnel pizza oven has been produced on the basis of this experience and know-how.

The tunnel pizza oven is a very rapid, quiet and compact oven with radiant heat and a temperature of up to 400°C, making possible high capacity and controlled baking of pizzas and other products, for example, hamburgers, sausage, fish. Sveba-Dahlen's tunnel pizza oven is available in two sizes, both with up to three sections vertically, and stepless baking time setting.

With an easy to use touch screen with week timer. With 5 program settings and energy saving mode the oven is efficient and easy to operate for anybody.



Options

The TP is delivered as standard, with aluminium legs 600 mm long (1-2 sections) and 400 mm long (3 sections) respectively, on castors. The TP can be delivered with optional leg length upon request.

TP standard features

Two standard widths up to three sections height.

Stainless steel exterior and well insulated oven chamber.

Easy to use touch screen.

Energy saving mode

Baking chamber in two zones.

Canopies at infeed and outfeed ends.

Removeable extraction tray at outfeed and infeed.

Self cleaning oven chamber.

Stainless steel mesh belt.

Digital Panel



- Individual temperature and power setting of each zone.
- 5 program settings
- Energy saving mode
- Week timer – individual start times for each day of the week.
- Clear and easy to read monochrome touch screen.
- Possibility to select user language in the screen.

500 pizzas per hour

TP is a very quiet and flexible oven, easily adapted for various capacity requirements. Stepless setting of baking times and up to three wholly independent sections vertically make possible high capacity both as regards the number and variation of the products which can be baked. Pizzas, pies and pita bread pass through during a baking time from 2 to 10 minutes.

Easy to keep clean

With correct time setting and temperature, the pizza is ready when it has passed through the oven. Smooth surfaces, both internally and externally with self cleaning oven chamber.

Up to 400°C

The TP is equipped with top and bottom radiant heat for working temperatures of up to 400°C. The pizza can be baked very quickly with a crispy surface and without drying out the inside, so that all flavours are retained.

The oven chamber is divided into two zones which gives an optimal baking result and reduces the risk of temperature loss. The temperature and power settings of top and bottom heat are controlled in each zone with four temperature sensors. Rapid reaction combined with radiation cover reduces the risk of uneven baking.

Capacity

The capacity of a TP-12 in which pizzas have been baked in baking trays, without pre-baking.

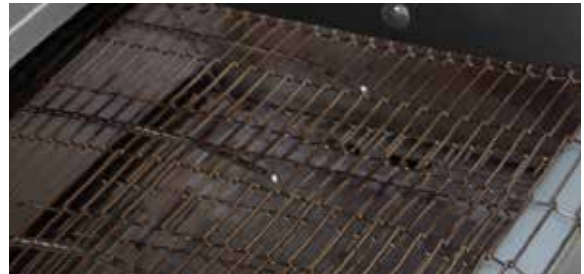
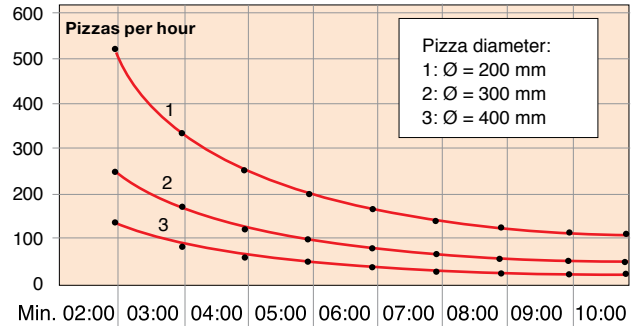

Technical

BELT WIDTH 381 MM	TP-10	TP-10	TP-10
No of decks/El. load, kW	1 / 9.5	2 / 18.5	3 / 28
BELT WIDTH 585 MM	TP-11	TP-21	TP-31
No of decks/El. load, kW	1 / 12	2 / 24	3 / 36
BELT WIDTH 900 MM	TP-12	TP-22	TP-32
No of decks/El. load, kW	1 / 18	2 / 36	3 / 54

Specification

MODEL	BAND W X L (MM)	BAKING SURF. M ²	INT. OVEN HGT MM	MAX. T. °C	BAKING TIME MIN.	POWER KW
TP-10	381 x 1750	N/A	N/A	400	2-10	12
TP-11	585 x 1750	0.5	90	400	2-10	12
TP-12	900 x 1750	0.76	90	400	2-10	18

Measurements TP-10

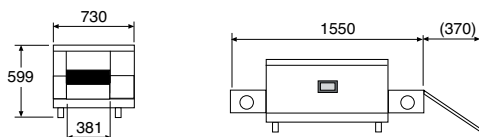

Measurements

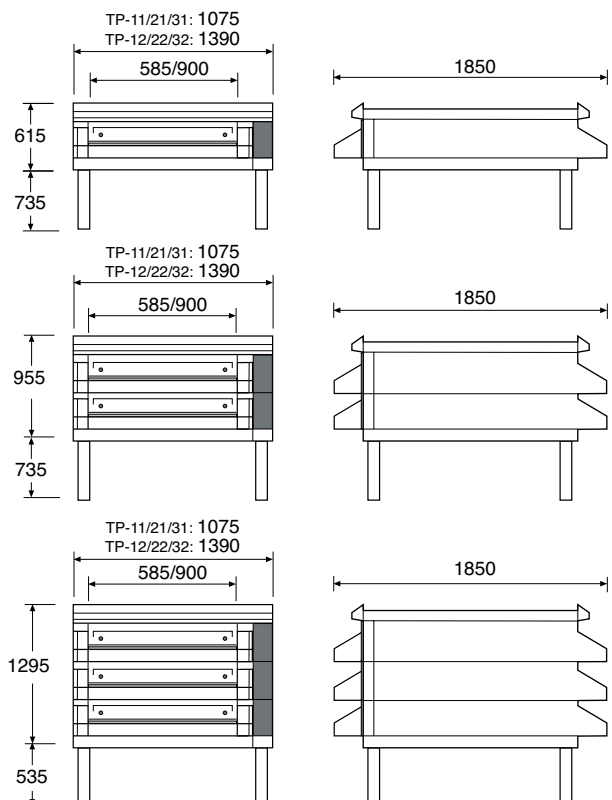

Subjects to changes without notice.

Trendy Pizza Oven

Trendy Pizza Oven A trendy pizza oven.

The Trendy Pizza oven represents a new generation of pizza ovens from Sveba-Dahlen. A new approach, including co-operation with experienced pizza che's, has given us a modern, easy-to-use, compact oven.

The oven's capacity, user-friendly panels with built-in thermostat and an automatic "turbo function" gives you an oven with almost unbeatable operating economy. When you want to upgrade your restaurant, the Trendy Pizza oven is the obvious choice.



Trendy Pizza – filled with advantages:

Built-in thermostat

Automatic turbo function

Separate heat control of oven chambers

Stepless control of front, top and bottom heat

Heat-reflecting toughened glass in oven doors

Halogen lighting on both sides

Unloading shelf and stainless shelf level on the leg supports

Lockable wheels

Integrated hood with extractor

Built-in automatic AC-guard

2.5-metre cable for connection to 3 phase outlet

Backup fuse 25 or 35 A

Weight 356 kg

Compact crate; 142 x 81 x 126 cm



Double side halogen lighting. Oven doors with heat-reflecting toughened glass.

Extra oven features:

Automatic turbo function

To get a quicker rise in temperature the Trendy Pizza oven is provided with an automatic turbo function. This function makes it possible to increase the temperature in the oven in the shortest possible time. Saves time and money during your rush hours.

Built-in week timer

In order to make your work as easy as possible, the Trendy Pizza oven has a built-in week timer as standard. The oven already has the correct working temperature when you get to work, and you can begin baking straight away.

Energy saving function

The digital panel can be programmed so that it takes into account the size of the fuses you have in the restaurant. This saves you money. The panel allocates power efficiently between both oven chambers and means that you can connect the oven to a lower Fuse.

Easy to install

The compact design enables you to install the Trendy Pizza oven in tight working spaces. The size of the oven is suitable for passing through a normal standard door.

1 Modern design

With its trendy appearance and user-friendly control panel, the Trendy Pizza is an excellent representative of the new generation of pizza ovens. The smooth stainless steel exterior and recessed panels give one the feeling of a real quality oven. The oven doors give a good overview of the oven chamber, reduces heat radiation and are easy to clean. Double halogen lighting gives you a good and reliable working light.

2 Easy to use

The oven is developed in co-operation with pizza bakers with high demands regarding usefulness and functionality. The most demanded features were: easy to use, easy to keep clean, rapid baking and a built-in thermostat. The Trendy Pizza fulfils all these requirements. Addition-ally, the new technology makes the oven silent and gives you a more quite restaurant environment. Our further developed stone soles, with improved heating features, result in quicker baking and more tasteful pizzas. Each oven section can be regulated separately, and the oven is provided with active front heating which copes with the frequent door openings.



Specification

MODEL	INTERIOR MEAS.	EL. LOAD KW	MAX BAKING T.
Trendy Pizza	1060 x 700	19	370°C

User-friendly panel

User-friendly panel with which you can control both oven chambers separately. The panel is completely flat and easy to clean.

Upper oven chamber:
Functions and temperature

Increase/decrease
temperature/power

Lower oven chamber:
Functions and temperature



Measurements

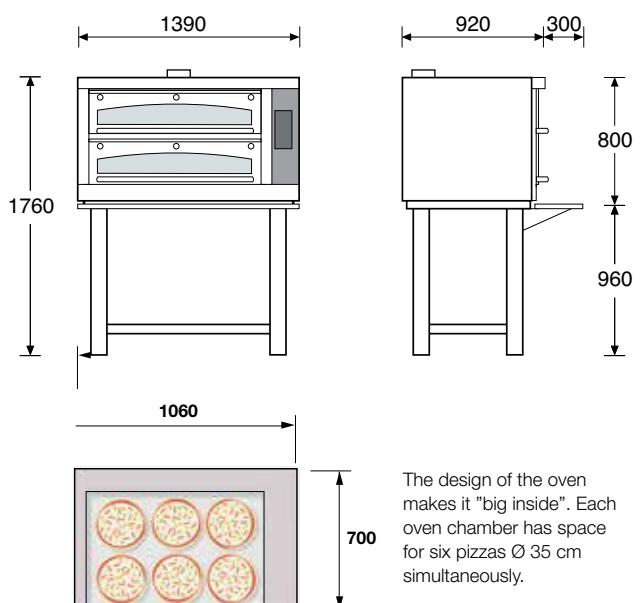

Subjects to changes without notice.

**We have the oven for
your restaurant!**



Sveba-Dahlen has developed and delivered pizza ovens worldwide since 1970. Our pizza ovens are robust, reliable and designed to satisfy all the pizza baker's requirements for functionality, comfort and economy.

Visit our website!



The baker's best friend

www.sveba-dahlen.com

Sveba-Dahlen AB, 518 32 Fristad
Tel: +46 33 15 15 00, Fax: +46 33 15 15 99, mail@sveba-dahlen.se